

Stella Neon Flex

Stella LED ネオン製品シリーズは、サイドバンドとトップバンドの両方のオプションを網羅しており、単色、デュアルカラー、RGB、RGBW、および色変更オプションがあります。

これらのLEDネオンライトは、屋外 (IP67) および水中 (IP68) 用途に適しています。照明、看板、屋外広告、イベントおよびエンターテインメント、装飾照明。目を引くディスプレイを作成するのに最適です。建物の特徴を強調し、屋外スペースを強化し、鮮やかな視覚効果を追加します。



Side Bend

サイドベンディングLEDネオンフレックスの特徴はドットフリー照明です。より長く、より高い寿命を実現。有効性、高いCRIになるよう設計されています。さまざまな照明に対応。コープ照明のアプリケーション、間接照明など。



Top Bend

トップベンディングLEDネオンフレックスの特徴はドットフリー照明です。より長く、より高い寿命を実現。有効性、高いCRIになるよう設計されています。さまざまな照明に対応。コープ照明のアプリケーション、間接照明など。



3D

トップバンドとサイドバンド同時に実現できます。曲げる方向に決まりはありません。自由な方向に曲げることができます。

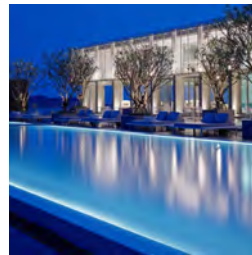

IP68 Waterproof

スイミングプールに適しております。深さ3mまでの水中での使用が可能です。塩水耐性、難燃性、耐衝撃性。



360 Round

全方向ネオンフレックスドットフリーと360°の照射。装飾照明、ホール、廊下、その他。



Side Bend

サイド/水平ベンディングLEDネオンフレックスはドットフリーが特徴です。
長寿命、高効率、高演色性を備えた設計です。
ホテルのコーブ照明や間接照明など。レストラン、ショップ、オフィス、家庭など。

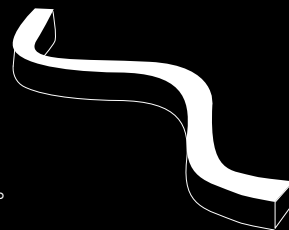

Stella Side Slim MF-SE-0410F



Electrical & Mechanical Technical Data

Dimension	4*10mm
Diffuser type	Flat
Voltage	12V/24V 48V dc
IP Rating	IP65
Maxrun	5-20m
Ambient temp.	-30°C ~ 40°C

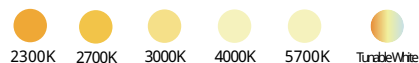

Specifications

Dimensions

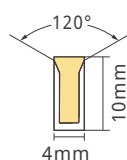

Bend radius

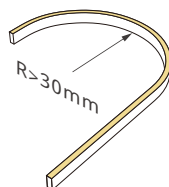

Mounting

Alu.profile/clips

Bendable profile

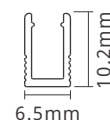

Extruded cable directions

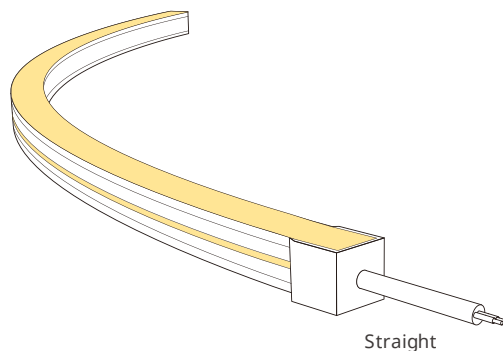

Straight



* Cable channels / standard 200mm

Cable output

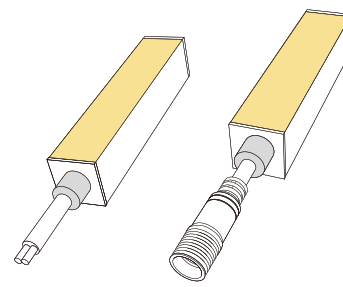

Wire

Connector

Light Technical Data

Type	CRI	CCT/Color	Cut Length	Power W/m
				8
			mm(24V)	lm/m
Single color	Single color	Red,Green,Blue,Amber	41.6	/
Static White	Ra80+, Ra90+, Ra95+	23K 27K 30K 35K 40K 50K 57K	41.6	170~240
Tunable White	Ra80+, Ra90+, Ra95+	27+57K or other CCT combination	31.25	160~230

Stella Side Slim MF-SE-0612F



Electrical & Mechanical Technical Data

Dimension	6*12mm
Diffuser type	Flat
Voltage	12V/ 24V 48V dc
IP Rating	IP67
Maxrun	5-20m
Ambient temp.	-30°C ~ 40°C

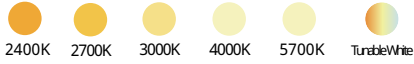

Specifications

Dimensions

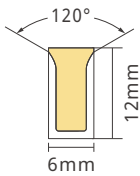

Bend radius

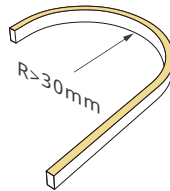

Mounting

Alu.profile/clips

Bendable profile

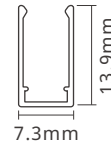

Extruded cable directions

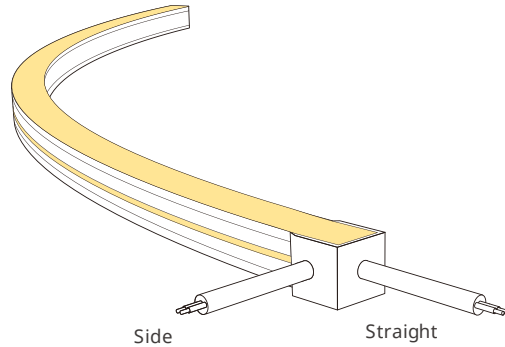

* Cable channels / standard 200mm

Cable output

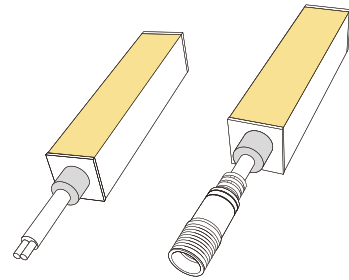

Wire

Connector

Light Technical Data

Type	CRI	CCT/Color	Cut Length	Power W/m	
				9.6	12
Single color	Single color	Red,Green,Blue,Amber	50 mm(24V)	Im/m	Im/m
Static White	Ra80+, Ra90+, Ra95+	23K 27K 30K 35K 40K 50K 57K	50	250~300	-
Tunable White	Ra80+, Ra90+, Ra95+	27+57K or other CCT combination	50	250~300	-
RGB	RGB	RGB	50	-	114

Stella Side Slim MF-SE1010F



Electrical & Mechanical Technical Data

Dimension	10*10mm
Diffuser type	Flat
Voltage	12V/24V 48V dc
IP Rating	IP67
Maxrun	5-20m
Ambient temp.	-30°C ~ 40°C

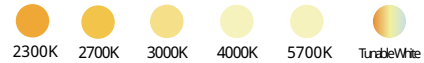

Specifications

Dimensions 	Bend radius 	Mounting Alu.profile/clips 	Bendable profile
-----------------------	------------------------	--	----------------------

Extruded cable directions

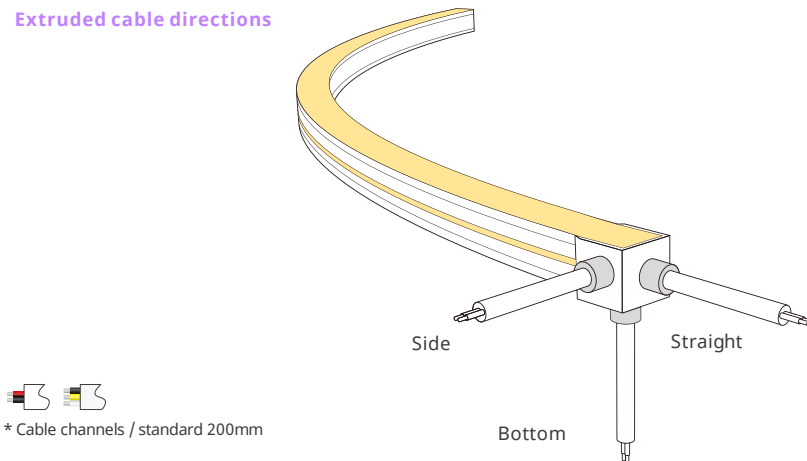

Cable output

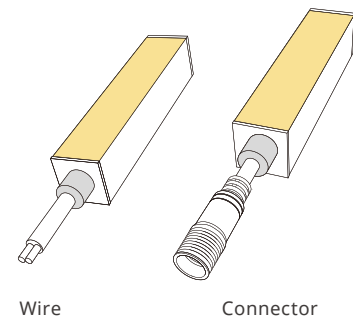

Light Technical Data

Type	CRI	CCT/Color	Cut Length	Power W/m
				9.6
			mm(24V)	lm/m
Single color	Single color	Red,Green,Blue,Amber	50	/
Static White	Ra80+, Ra90+, Ra95+	23K 27K 30K 35K 40K 50K 57K	50	250~300
Tunable White	Ra80+, Ra90+, Ra95+	27+57K or other CCT combination	50	250~300

Stella Side MF-SE1212F



Electrical & Mechanical Technical Data

Dimension	12*12mm
Diffuser type	Flat
Voltage	12V/ 24V 48V dc
IP Rating	IP67
Maxrun	5-20m
Ambient temp.	-30°C ~ 40°C

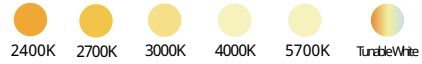

Specifications

<p>Dimensions</p>	<p>Bend radius</p>	<p>Mounting Alu.profile/clips</p> <p>Bendable profile</p>
<p>Extruded cable directions</p> <p>Side Straight</p> <p>Bottom</p> <p>* Cable channels / standard 200mm</p>	<p>Cable output</p> <p>Wire Connector</p>	

Light Technical Data

Type	CRI	CCT/Color	Cut Length mm(24V)	Power W/m	
				9.6	12
Single color	Single color	Red,Green,Blue,Amber	50	lm/m	lm/m
Static White	Ra80+, Ra90+, Ra95+	23K 27K 30K 35K 40K 50K 57K	50	/	-
Tunable White	Ra80+, Ra90+, Ra95+	27+57K or other CCT combination	50	250~300	-
RGB	RGB	RGB	50	-	114

Stella Side MF-SE1616F



Electrical & Mechanical Technical Data

Dimension	16*16mm
Diffuser type	Flat
Voltage	12V/ 24V 48V dc
IP Rating	IP67
Maxrun	5-20m
Ambient temp.	-30°C ~ 40°C

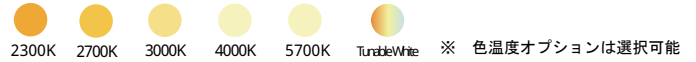

Specifications

Dimensions

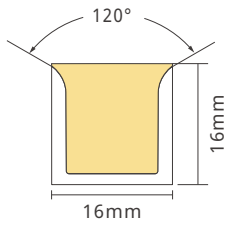

Bend radius

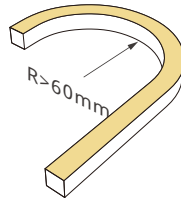

Mounting

Alu.profile/clips

Bendable profile

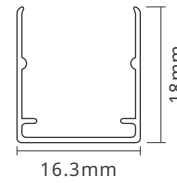

Extruded cable directions

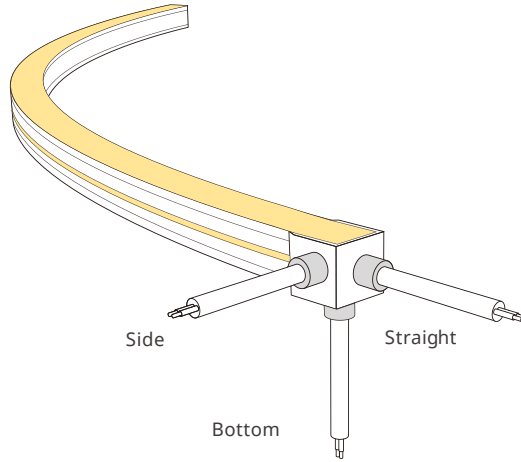

* Cable channels / standard 200mm

Cable output

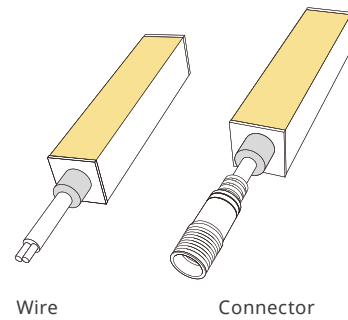

Light Technical Data

Type	CRI	CCT/Color	Cut Length	Power W/m			
				9.6	14.4	17.3	23
			mm(24V)	lm/m	lm/m	lm/m	lm/m
Single color	Single color	Red,Green,Blue,Amber	50	/	/	-	-
Static White	Ra80+, Ra90+, Ra95+	23K 27K 30K 35K 40K 50K 57K	50	165~215	245~325	-	-
Tunable White	Ra80+, Ra90+, Ra95+	27+57K or other CCT combination	62.5	165~215	245~325	-	-
RGB	RGB	RGB	83.3	-	125	-	-
RGBW	Ra80+, Ra90+, Ra95+	23K 27K 30K 35K 40K 50K 57K	83.3	-	142	-	-
Pixel RGB	RGB	RGB	83.3	-	-	145	-
Pixel RGBW	Ra80+, Ra90+, Ra95+	23K 27K 30K 35K 40K 50K 57K	83.3	-	-	-	232

Stella Side SE2020F



Electrical & Mechanical Technical Data

Dimension	20*20mm
Diffuser type	Flat
Voltage	12V/24V 48V dc
IP Rating	IP67
Maxrun	5-20m
Ambient temp.	-30°C ~ 40°C

※ 色温度オプションは選択可能

※演色評価数オプションは選択可能。

Specifications

Dimensions

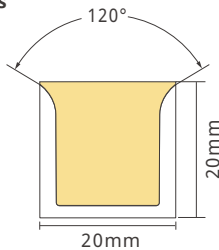

Bend radius

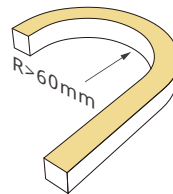

Mounting

Alu.profile/clips

Bendable profile

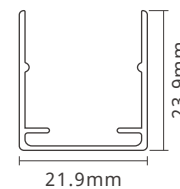

Extruded cable directions

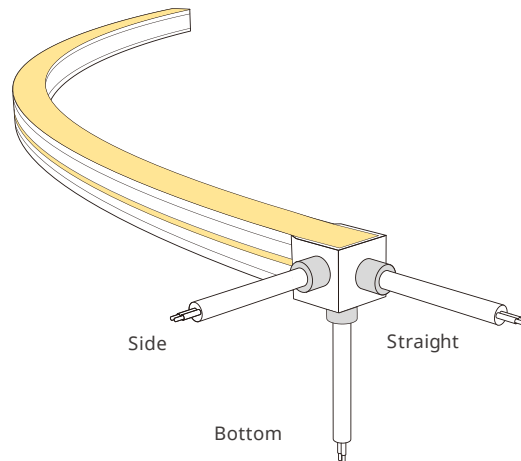

* Cable channels / standard 200mm

Cable output

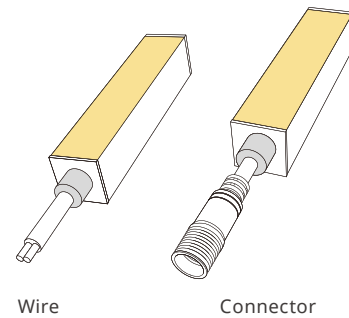

Light Technical Data

Type	CRI	CCT/Color	Cut Length	Power W/m			
				9.6	14.4	17.3	23
			mm(24V)	lm/m	lm/m	lm/m	lm/m
Single color	Single color	Red,Green,Blue,Amber	50	/	/	-	-
Static White	Ra80+, Ra90+, Ra95+	23K 27K 30K 35K 40K 50K 57K	50	165~215	245~325	-	-
Tunable White	Ra80+, Ra90+, Ra95+	27+57K or other CCT combination	62.5	165~215	245~325	-	-
RGB	RGB	RGB	50	-	125	-	-
RGBW	Ra80+, Ra90+, Ra95+	23K 27K 30K 35K 40K 50K 57K	83.3	-	142	-	-
Pixel RGB	RGB	RGB	83.3	-	-	145	-
Pixel RGBW	Ra80+, Ra90+, Ra95+	23K 27K 30K 35K 40K 50K 57K	83.3	-	-	-	232

Top Bend

トップ/水平ベンディングLEDネオンフレックスはドットフリーが特徴です。
長寿命、高効率、高演色性を備えた設計です。
ホテルのコーブ照明や間接照明など。レストラン、ショップ、オフィス、家庭など。

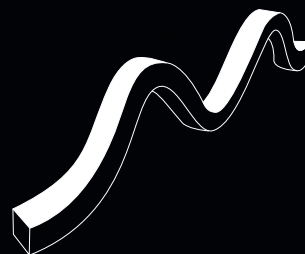

Stella Top MF-TE1010F



Electrical & Mechanical Technical Data

Dimension	10*10mm
Diffuser type	Flat
Voltage	12V/ 24V 48V dc
IP Rating	IP67
Maxrun	5-20m
Ambient temp.	-30°C ~ 40°C

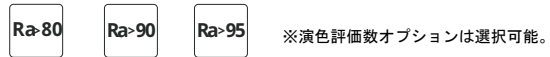
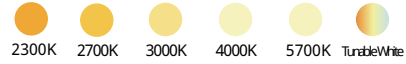

Specifications

Dimensions

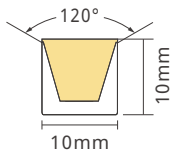

Bend radius

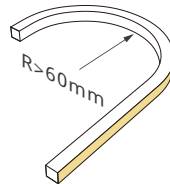

Mounting

Alu.profile/clips

Bendable profile

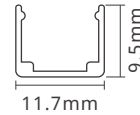

Extruded cable directions

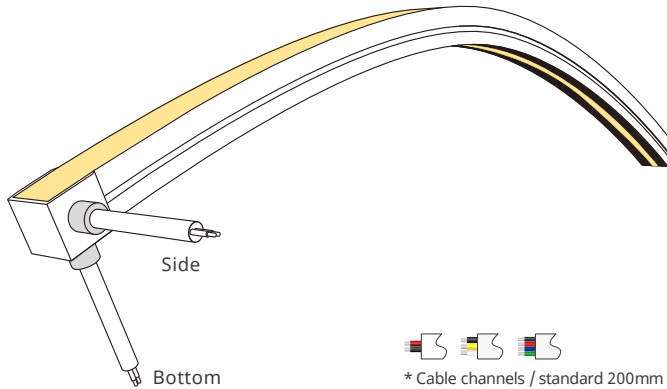

Cable output

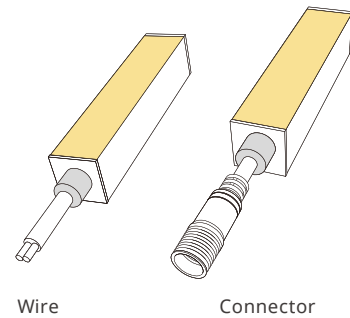

Light Technical Data

Type	CRI	CCT/Color	Cut Length mm(24V)	Power W/m		
				9.6 lm/m	12 lm/m	14.4 lm/m
Single color	Single color	Red,Green,Blue,Amber	50	/	/	-
Static White	Ra80+, Ra90+, Ra95+	23K 27K 30K 35K 40K 50K 57K	50	350~475	430~590	-
Tunable White	Ra80+, Ra90+, Ra95+	27+57K or other CCT combination	50	350~475	430~590	-
RGB	RGB	RGB	50	170	216	260

Stella Top MF-TE-1616F

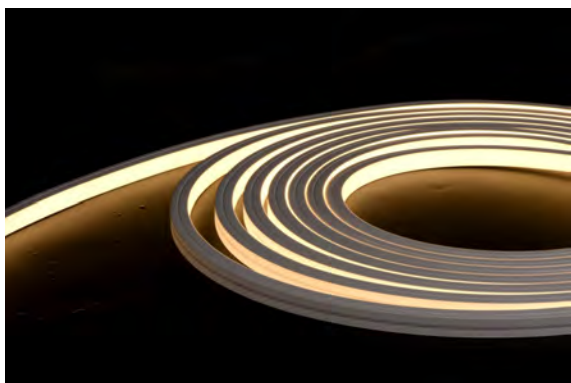

Electrical & Mechanical Technical Data

Dimension	16*16mm
Diffuser type	Flat
Voltage	12V/24V 48V dc
IP Rating	IP67
Maxrun	5-20m
Ambient temp.	-30°C ~ 40°C



※演色評価数オプション選択可能。

Specifications

Dimensions

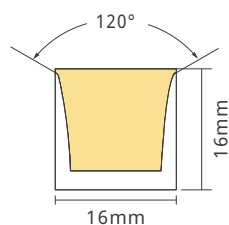

Bend radius

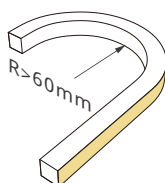

Mounting

Alu.profile/clips

Bendable profile

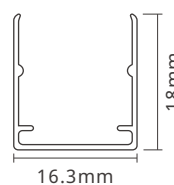

Extruded cable directions

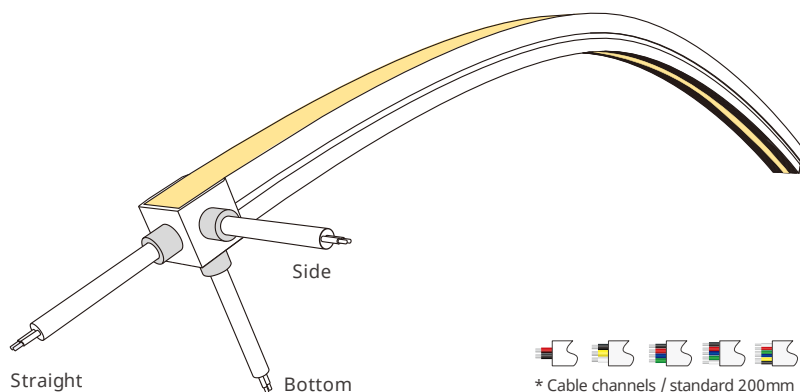

* Cable channels / standard 200mm

Cable output

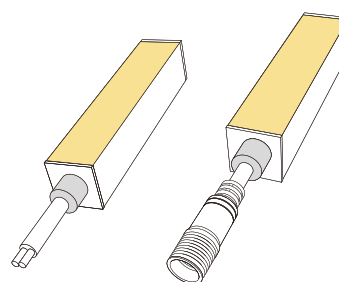

Wire

Connector

Light Technical Data

Type	CRI	CCT/Color	Cut Length	Power W/m			
				9.6	14.4	17.3	23
Single color	Single color	Red,Green,Blue,Amber	50	/	/	-	-
Static White	Ra80+, Ra90+, Ra95+	23K 27K 30K 35K 40K 50K 57K	50	330~430	490~650	-	-
Tunable White	Ra80+, Ra90+, Ra95+	27+57K or other CCT combination	62.5	330~430	490~650	-	-
RGB	RGB	RGB	83.3	-	250	-	-
RGBW	Ra80+, Ra90+, Ra95+	23K 27K 30K 35K 40K 50K 57K	83.3	-	285	-	-
Pixel RGB	RGB	RGB	83.3	-	-	290	-
Pixel RGBW	Ra80+, Ra90+, Ra95+	23K 27K 30K 35K 40K 50K 57K	83.3	-	-	-	465

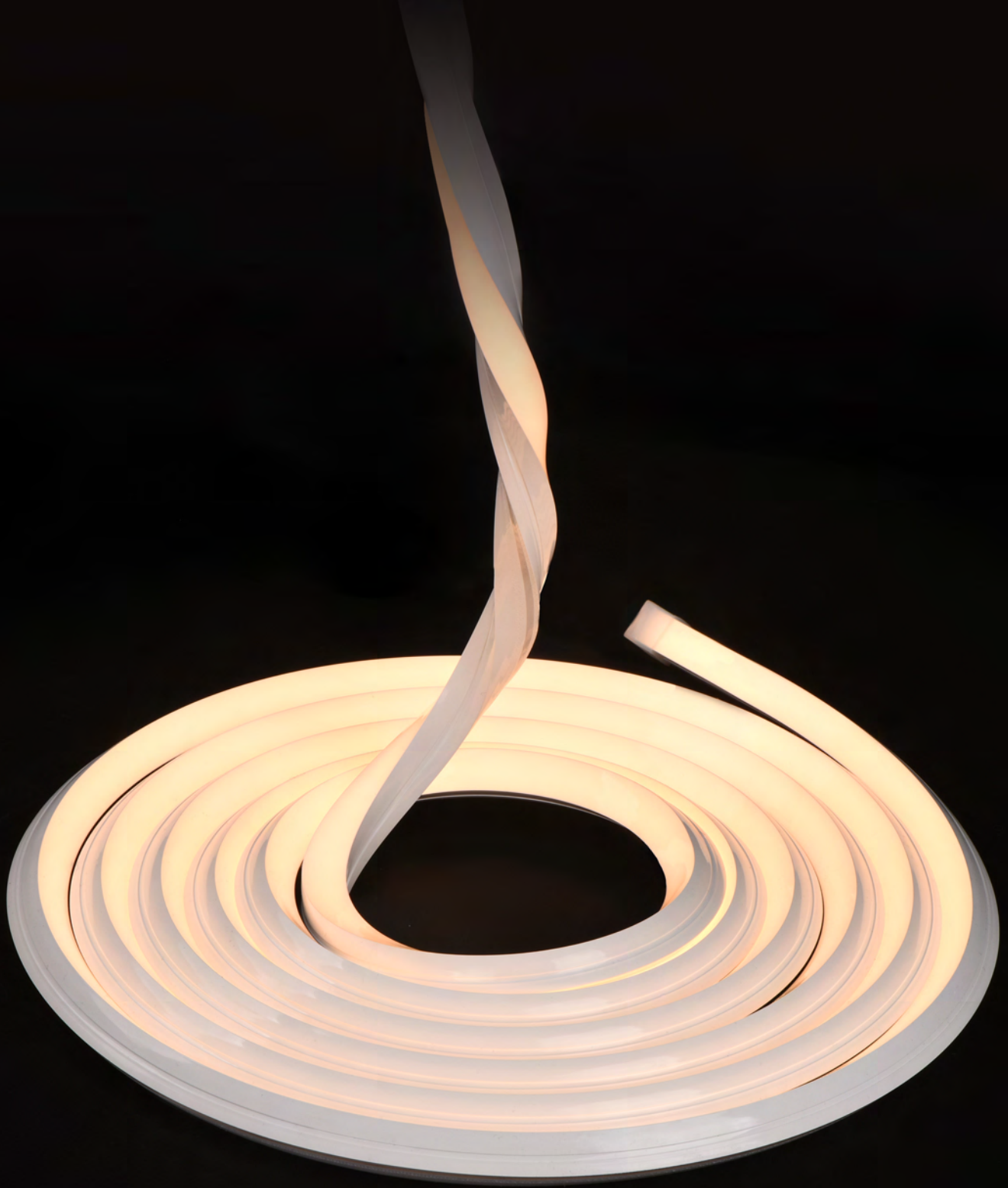

3D

上曲げと横曲げを同時に実現可能。
デザインの自由度が向上します。



Stella MF-3D-TE-1313F



Electrical & Mechanical Technical Data

Dimension	13*13mm
Diffuser type	Flat
Voltage	12V/ 24V 48V dc
IP Rating	IP67
Maxrun	5-20m
Ambient temp.	-30°C ~ 40°C



※ 色温度オプションは選択可能



Specifications

<p>Dimensions</p>	<p>Bend radius</p>	<p>Mounting Alu.profile/clips</p> <p>Bendable profile</p>
<p>Extruded cable directions</p> <p>Bottom</p> <p>* Cable channels / standard 200mm</p>		<p>Cable output</p> <p>Wire</p> <p>Connector</p>

Light Technical Data

Type	CRI	CCT/Color	Cut Length	Power W/m
				8
Single color	Single color	Red,Green,Blue,Amber	41.6 mm(24V)	lm/m /
Static White	Ra80+, Ra90+, Ra95+	23K 27K 30K 35K 40K 50K 57K	41.6	320~400

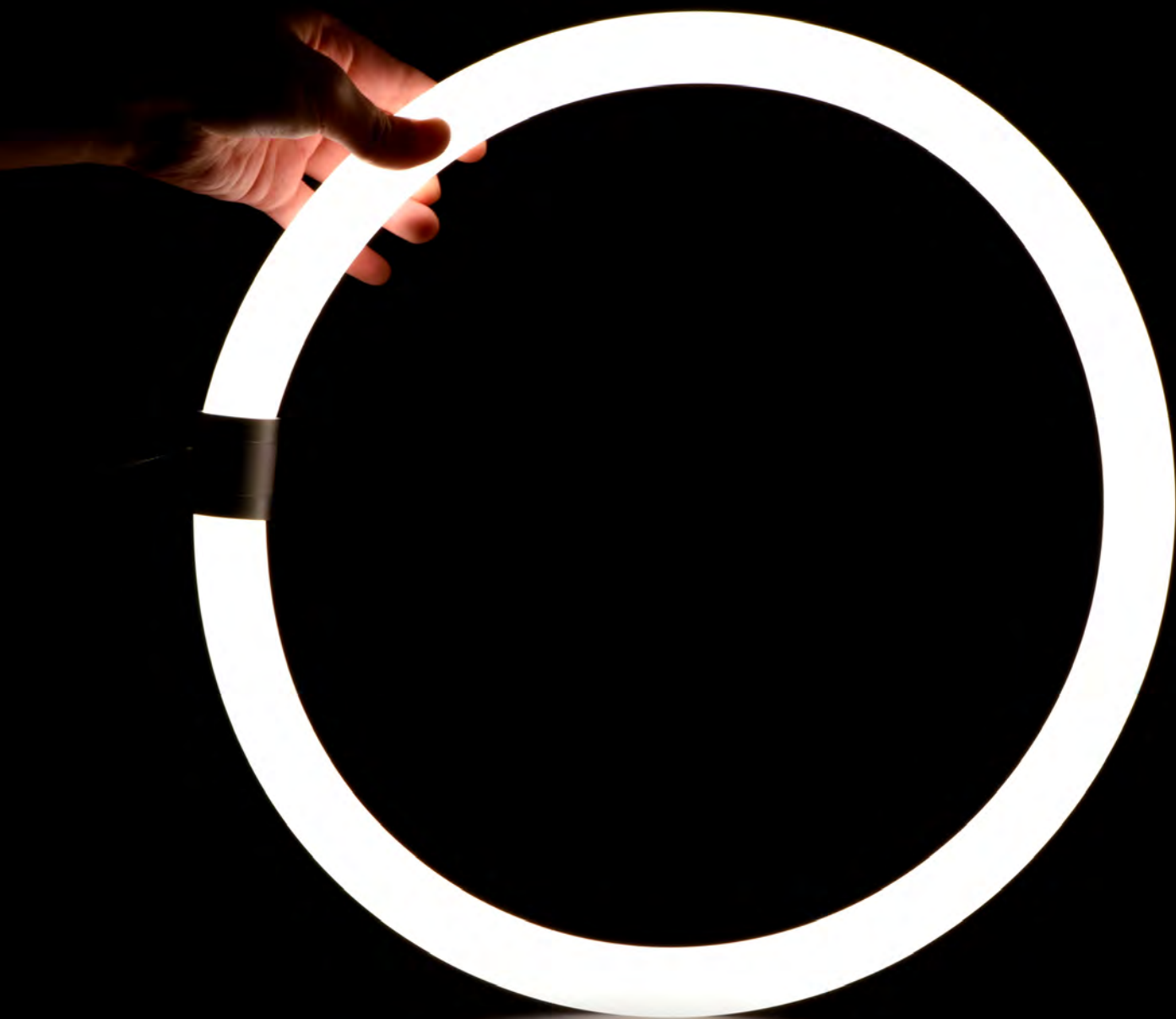

360 Round

全方向性ネオンフレックスはドットフリーと360°が特徴です。
自由に曲げることができるので装飾照明に最適です。
レセプションホール、廊下、その他の会場など。

Stella MF-360 Round D13



Electrical & Mechanical Technical Data

Dimension	φ13mm
Diffuser type	Omni 360Deg.
Voltage	12V/ 24V 48V dc
IP Rating	IP67
Maxrun	5-20m
Ambient temp.	-30°C ~ 40°C

● 2300K
 ● 2700K
 ● 3000K
 ● 4000K
 ● 5700K
 ※ 色温度オプションは選択可能

● Red
 ● Green
 ● Blue
 ● Amber

Ra>80
Ra>90
Ra>95
 ※演色評価数オプションは選択可能。

Specifications

Dimensions

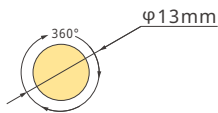

Bend radius

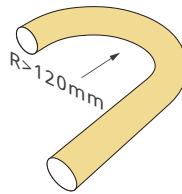

Instructions

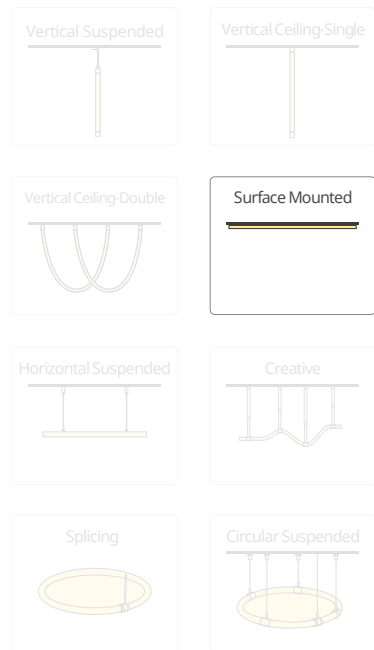

Extruded cable directions

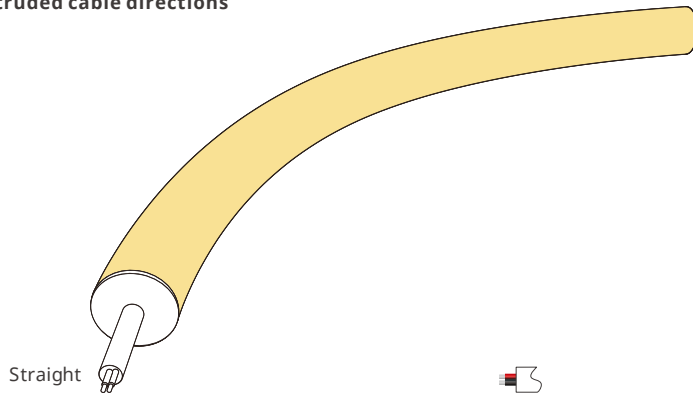

* Cable channels / standard 200mm

Light Technical Data

Type	CRI	CCT/Color	Cut Length	Power W/m	
				10	
			mm(24V)	lm/m	
Single color	Single color	Red,Green,Blue,Amber	27.7	/	
Static White	Ra80+, Ra90+, Ra95+	23K 27K 30K 35K 40K 50K 57K	27.7	350~500	

Stella MF-360 Round D18



Electrical & Mechanical Technical Data

Dimension	φ18mm
Diffuser type	Flat
Voltage	12V/ 24V 48V dc
IP Rating	IP67
Maxrun	5-20m
Ambient temp.	-30°C ~ 40°C

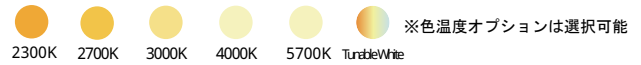

Specifications

Dimensions

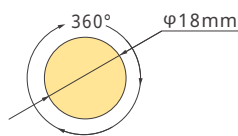

Bend radius

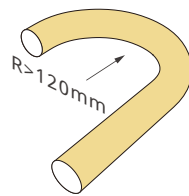

Extruded cable directions

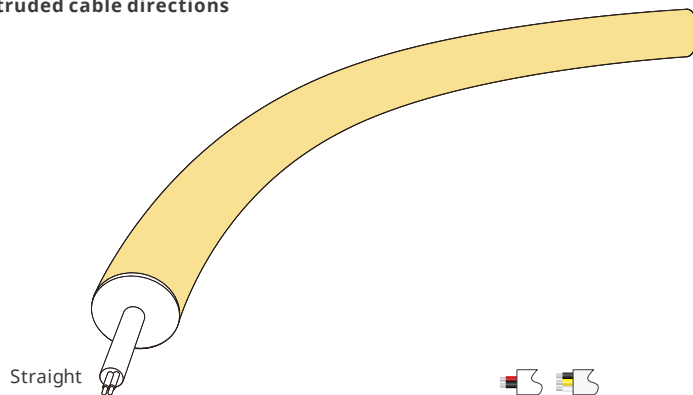

* Cable channels / standard 200mm

Instructions

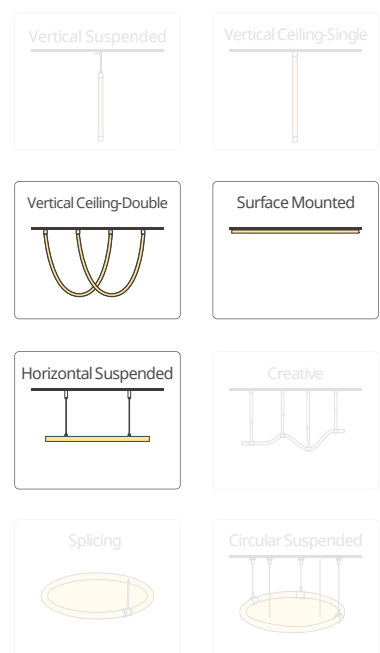

Light Technical Data

Type	CRI	CCT/Color	Cut Length	Power W/m	
				mm(24V)	lm/m
Single color	Single color	Red,Green,Blue,Amber	41.6		/
Static White	Ra80+, Ra90+, Ra95+	23K 27K 30K 35K 40K 50K 57K	11.9		500~720
Tunable White	Ra80+, Ra90+, Ra95+	27+57K or other CCT combination	62.5		430~650

Stella MF-360 Round D25



Electrical & Mechanical Technical Data

Dimension	φ25mm
Diffuser type	Omni 360Deg.
Voltage	12V/24V 48V dc
IP Rating	IP67
Maxrun	5-20m
Ambient temp.	-30°C ~ 40°C

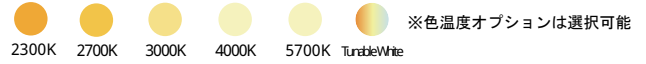

Specifications

Dimensions

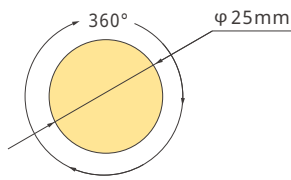

Bend radius

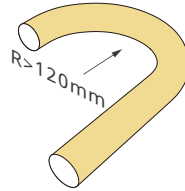

Extruded cable directions

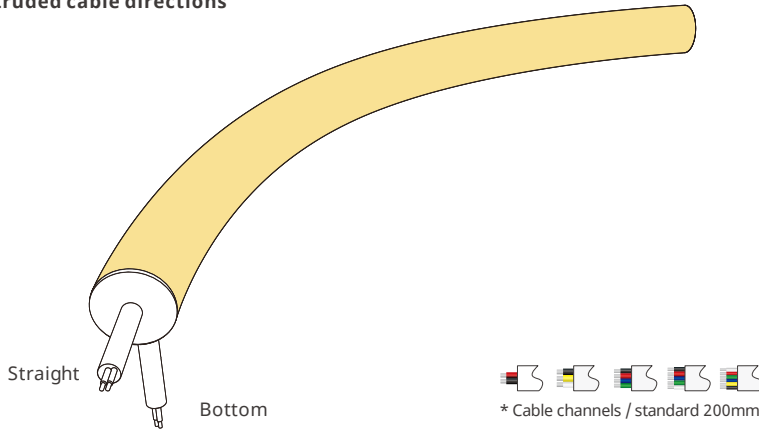

Instructions

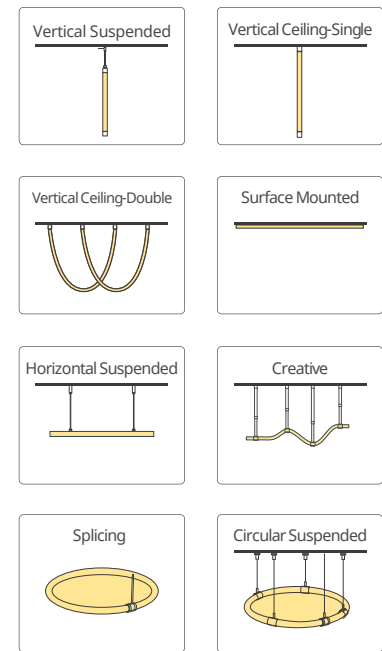

Light Technical Data

Type	CRI	CCT/Color	Cut Length	Power W/m			
				14.4	19.2	34.6	46
			mm(24V)	lm/m	lm/m	lm/m	lm/m
Single color	Single color	Red,Green,Blue,Amber	41.6	/	-	-	-
Static White	Ra80+, Ra90+, Ra95+	23K 27K 30K 35K 40K 50K 57K	11.9	500~720	-	-	-
Tunable White	Ra80+, Ra90+, Ra95+	27+57K or other CCT combination	62.5	430~650	-	-	-
RGB	RGB	RGB	50	260	-	-	-
RGBW	Ra80+, Ra90+, Ra95+	23K 27K 30K 35K 40K 50K 57K	50	-	380	-	-
Pixel RGB	RGB	RGB	83.3	-	-	/	-
Pixel RGBW	Ra80+, Ra90+, Ra95+	23K 27K 30K 35K 40K 50K 57K	83.3	-	-	-	/

Stella MF-360 Round D25



Electrical & Mechanical Technical Data

Dimension	φ25mm
Diffuser type	Omni 360Deg.
Voltage	12V/24V 48V dc
IP Rating	IP67
Maxrun	5-20m
Ambient temp.	-30°C ~ 40°C

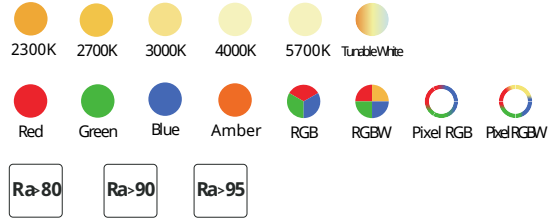

Specifications

Dimensions

Bend radius

Instructions

Extruded cable directions

* Cable channels / standard 200mm

Light Technical Data

Type	CRI	CCT/Color	Cut Length	Power W/m			
				14.4	19.2	34.6	46
				lm/m	lm/m	lm/m	lm/m
Single color	Single color	Red,Green,Blue,Amber	41.6	/	-	-	-
Static White	Ra80+, Ra90+, Ra95+	23K 27K 30K 35K 40K 50K 57K	11.9	500~720	-	-	-
Tunable White	Ra80+, Ra90+, Ra95+	27+57K or other CCT combination	62.5	430~650	-	-	-
RGB	RGB	RGB	50	260	-	-	-
RGBW	Ra80+, Ra90+, Ra95+	23K 27K 30K 35K 40K 50K 57K	50	-	380	-	-
Pixel RGB	RGB	RGB	83.3	-	-	/	-
Pixel RGBW	Ra80+, Ra90+, Ra95+	23K 27K 30K 35K 40K 50K 57K	83.3	-	-	-	/

Stella MF-360 Round D40

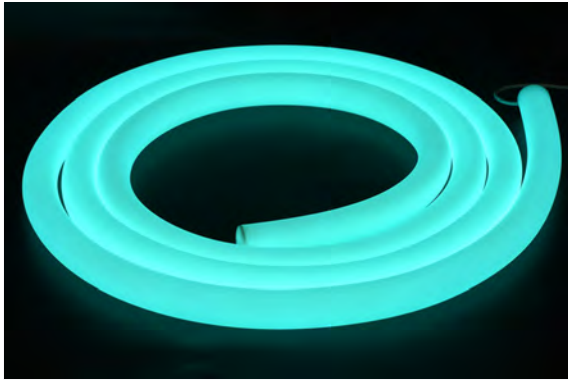

Electrical & Mechanical Technical Data

Dimension	φ40mm
Diffuser type	Omni 360Deg.
Voltage	12V/24V 48V dc
IP Rating	IP67
Maxrun	5-20m
Ambient temp.	-30°C ~ 40°C

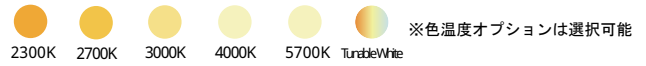

Specifications

Dimensions

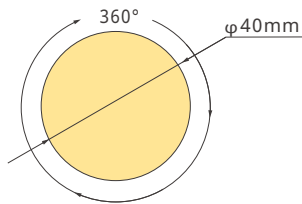

Bend radius

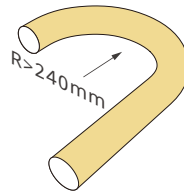

Extruded cable directions

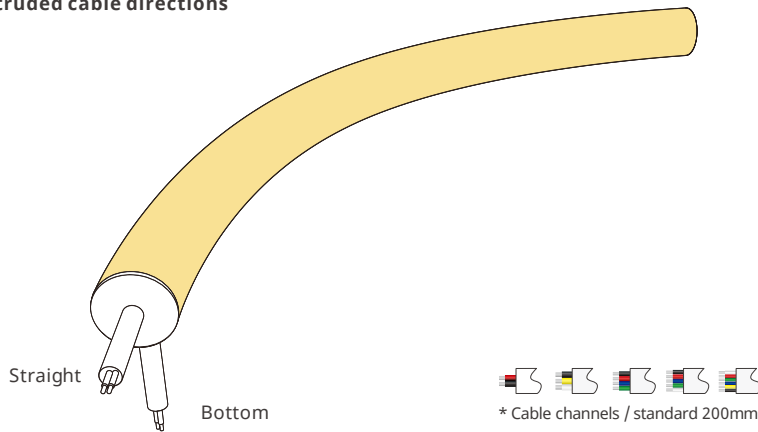

Instructions

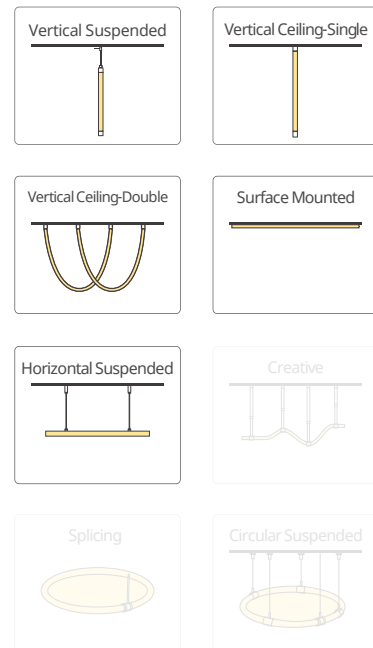

Light Technical Data

Type	CRI	CCT/Color	Cut Length	Power W/m			
				14.4	19.2	34.6	46
Single color	Single color	Red,Green,Blue,Amber	mm(24V)	lm/m	lm/m	lm/m	lm/m
Static White	Ra80+, Ra90+, Ra95+	23K 27K 30K 35K 40K 50K 57K	41.6	/	-	-	-
Tunable White	Ra80+, Ra90+, Ra95+	27+57K or other CCT combination	11.9	500~720	-	-	-
RGB	RGB	RGB	62.5	430~650	-	-	-
RGBW	Ra80+, Ra90+, Ra95+	23K 27K 30K 35K 40K 50K 57K	50	260	-	-	-
Pixel RGB	RGB	RGB	50	-	380	-	-
Pixel RGBW	Ra80+, Ra90+, Ra95+	23K 27K 30K 35K 40K 50K 57K	83.3	-	-	/	-
			83.3	-	-	-	/